

## MOUNTING INSTRUCTIONS

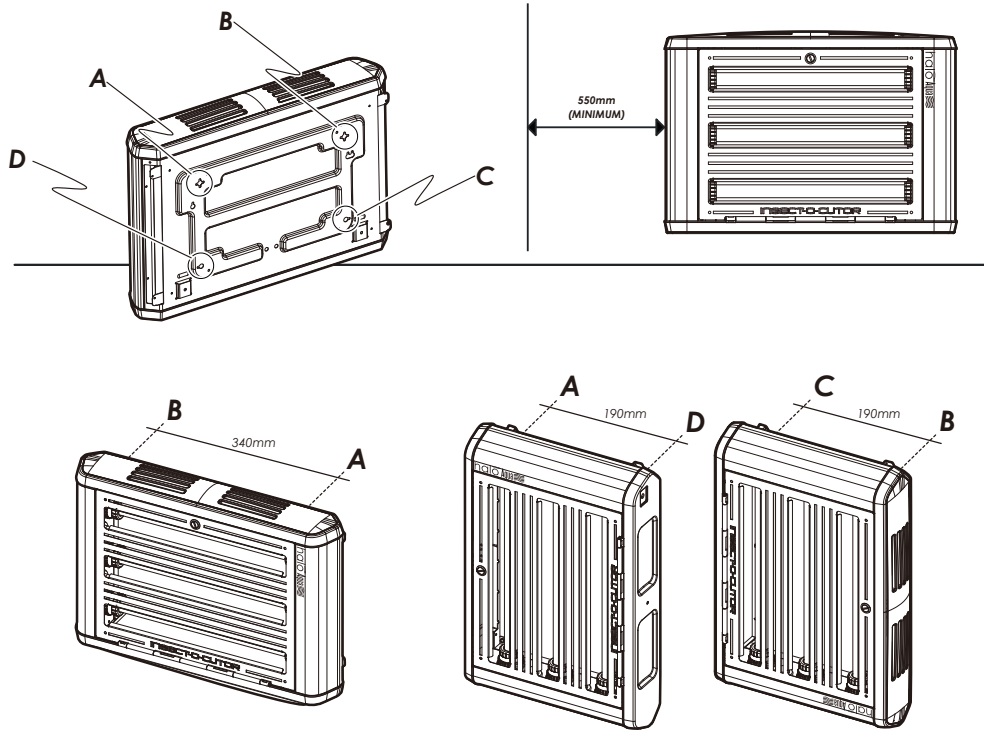

V171017

Information provided on these instructions is modified and updated from time to time. This is due to the constant redevelopment of our products. As such, it is not intended that you should rely on it or that it should form part of any contract. © 2017 Pelsis



Sterling House  
Grimbald Crag Close  
Knaresborough  
North Yorkshire  
HG5 8PJ UK

T +44 (0)800 988 5359  
F +44 (0)1423 863 497  
www.pelsis.com  
www.insect-o-cutor.co.uk  
info@pelsis.com



INSECT-O-CUTOR®

Product code  
HL45IPX

Description  
Halo 45 Aqua

Dimensions (mm) HxWxD  
588 x 404 x 118

Tubes  
3 x TPX15-18S

Glueboards (x6)  
GB013 (Yellow)

- Instruction booklet
- Notice d'utilisation
- Bedienungsanleitungssprachen
- Libretto istruzioni
- Instrukcję
- Manual de instrucciones
- livreto de instruções
- Instructieboekje
- Instruktionsboken

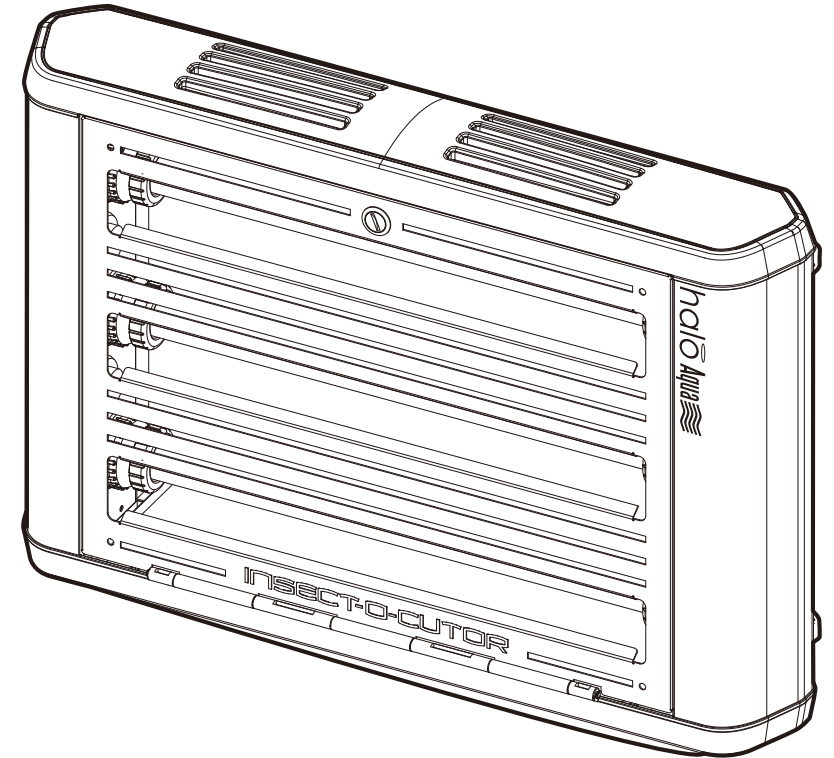

Please read these instructions carefully and store in a safe place for future reference.

### HALO AQUA

As part of the Insect-O-Cutor® brand of insect control products, **Halo Aqua** is a versatile professional flykiller which utilises highly effective UV tubes and is designed for use with a high specification Glupac® glueboard. **Halo Aqua** is available as a 45W single sided model or as a 90W double sided model. **Halo Aqua** is a IP45 rated model, available as either a wall mounted or a ceiling suspended version and is designed for use in demanding environments. The Halo range also includes a 15, 30 or 45W model which can be wall or desk mounted, and a 2x30W model for ceiling suspension.

### CONTENTS OF PACKAGE

- 1 x Halo Aqua flykiller
- 1 x Glupac® pheromone impregnated glueboard
- 1 x Removable aluminium debris trays
- 3 x High powered shatterproof UV tubes (fitted)
- 4 x Screws and wall plugs
- 2 x Vertical mount glueboard retaining pins
- 2 x Mains cable retaining pins
- 1 x Servicing key fob and mains cable tidy tie wrap wire

WARNING - THIS APPLIANCE MUST BE EARTHED (CLASS 1)

### INSECT CONTROL PRODUCTS

**Halo Aqua** utilises high powered ultra violet tubes to attract flying insects and retains the caught insects on a pheromone impregnated glueboard for inspection or hygienic disposal.

### WARNING

**Halo Aqua** is IP45 rated and is designed for use in applications appropriate to this ingress protection rating.

**Halo Aqua** is not to be used by children or persons with reduced physical, sensory or mental capabilities, or lack of experience and knowledge, unless they have been given supervision or instruction.

Children should be supervised to ensure they do not play with the appliance.

The mains cable cannot be replaced, if it is damaged the unit must be replaced.

**Halo Aqua** is not suitable for applications where potentially explosive environments may exist.

### POSITIONING AND GUIDANCE FOR USE

THIS UNIT IS FOR INDOOR USE ONLY. NOT SUITABLE FOR BARN, STABLES AND SIMILAR LOCATIONS.

**Halo Aqua** should ideally be fixed around two meters above the ground, preferably in the darkest place within the area to be protected. ENSURE THERE IS A MINIMUM OF 550mm BETWEEN ONE SIDE OF HALO AQUA AND THE ADJACENT SURFACE, TO PROVIDE ENOUGH SPACE TO INSERT THE GLUEBOARD (SEE MOUNTING INSTRUCTIONS.) Do not position the unit close to windows, skylights or other sources of light, or where it may be obscured by furniture, doors or other obstacles. Ideally, **Halo Aqua** should be visible from every part of the area to be protected.

**Halo Aqua** should ideally be in operation for 24 hours a day, ensuring your premises are kept free of flying insects. Insects are most attracted to **Halo Aqua** at night when there is no competition from daylight or other light sources.

\*Excludes tubes, glueboards and starters. Does not cover breakdown due to misuse, incorrect operation or use in an incorrect application.

### GUARANTEE

**Halo Aqua** has a three year guarantee and if maintained as recommended in these instructions should continue to work for many years.\* Use of non-approved consumables may invalidate the guarantee. Ensure genuine Glupac® glueboards are used in conjunction with this product.

### INSTALLATION

INSTALLATION SHOULD BE CARRIED OUT BY SERVICE PERSONNEL ONLY.

For wall mounting, use the supplied wall mounting plugs and screws, making sure correct wall plugs are used for specialist mounting materials, such as plasterboard.

**Wall Mounting - Halo Aqua** can be wall mounted horizontally or vertically. For horizontal mounting, use the two cut outs on the debris tray to mark the correct wall mounting points. For vertical wall mounting, insert the two large plastic glueboard retaining pins in the two holes on the glueboard runners, to stop the glueboard falling out of the unit. (Supplied in the fixing kit)

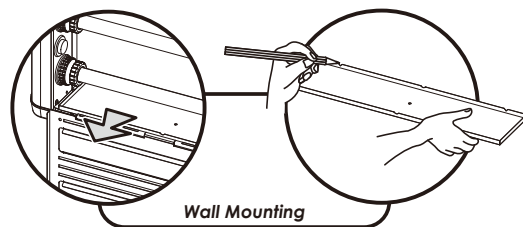

Wall Mounting

Once **Halo Aqua** is installed in position, fit the Glupac® glueboards in place as described in the glueboard replacement section of this document.

**Halo Aqua** should be hardwired into an appropriate power supply (as indicated on the specification label) by a qualified electrician. Use the supplied black mains cable tidy tie wrap wire to hide any excess mains cable behind the product if required.

To maximise the effectiveness of **Halo Aqua** in catching flying insects, the top of moulding has light apertures to increase the UV irradiance emitted from the product. However, if required, these apertures can be covered to protect the glueboard from debris and prolong its life, by simply sliding the reflective aluminium cover forward.

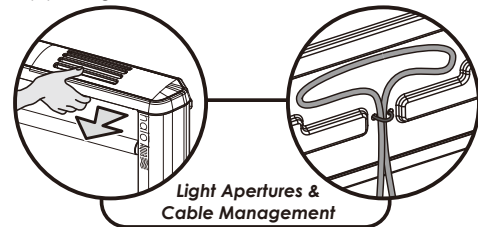

Light Apertures & Cable Management

### CLEANING

CLEANING SHOULD BE CARRIED OUT BY SERVICE PERSONNEL ONLY, AFTER ENSURING THAT THE UNIT IS DISCONNECTED FROM THE MAINS SUPPLY.

It is recommended that cleaning is carried out regularly when the glueboard is replaced. Once the glueboard is removed, the unit should be thoroughly wiped down with a damp cloth, removing any build up of dirt. Ensure the unit is completely dry before reconnecting it to the power supply.

### GLUEBOARD REPLACEMENT

GLUEBOARD REPLACEMENT SHOULD BE CARRIED OUT BY SERVICE PERSONNEL ONLY, AFTER ENSURING THAT THE UNIT IS DISCONNECTED FROM THE MAINS SUPPLY.

The glueboards should be replaced every month with genuine Glupac® glueboards. Use of non-approved glueboards may invalidate your guarantee. **Halo Aqua** comes supplied with high efficacy replacement yellow Glupac® glueboards, with printed grids for simple insect evaluation and monitoring.

To replace the glueboard...

1. Remove the used Glupac® glueboard by simply pulling it clear from either the left or right of the unit.
2. Remove the protective release paper from the new Glupac® glueboard.
3. Slowly slide the new Glupac® glueboard into position, until the glueboard 'drops' into the locator, indicating it is in the centre of the unit.

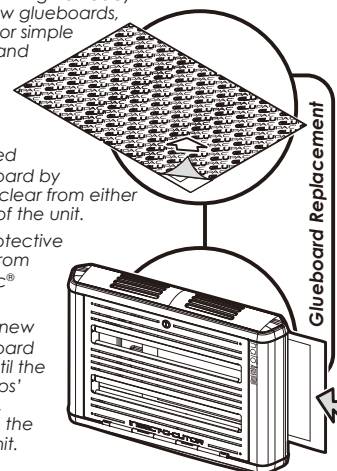

Glueboard Replacement

Always ensure the selected genuine Glupac® glueboards are compatible with your unit, available from your pest control operator or Pelsis Ltd.

### TUBE REPLACEMENT

TUBE REPLACEMENT SHOULD BE CARRIED OUT BY SERVICE PERSONNEL ONLY, AFTER ENSURING THAT THE UNIT IS DISCONNECTED FROM THE MAINS SUPPLY.

To ensure the efficiency of **Halo Aqua** in catching flying insects, the UV tubes should be replaced annually. After twelve months the phosphor coating that emits the correct wavelength of UV light has burnt away and the UV output is diminished substantially.

To replace the UV tubes...

1. Open the swing down front guard, by using the supplied servicing key fob.
2. Loosen the lampholder cap slightly, then rotate the lampholder anti-clockwise.
3. Repeat the process on the opposite lampholder, then slide them both towards the centre of the tube.

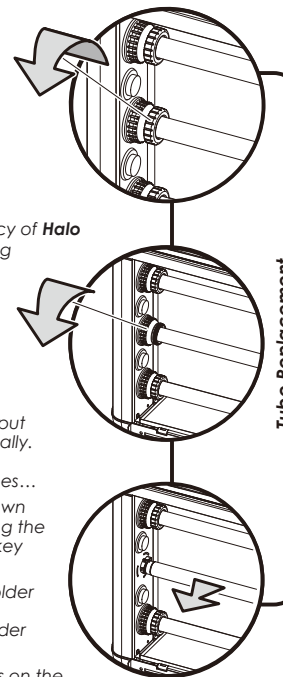

Tube Replacement

4. Rotate the tube through 90°, freeing it from the tube holders.
5. Pull the tube away from the chassis.
6. Dispose of the used UV tube in conjunction with local WEEE regulations.

### STARTER REPLACEMENT

STARTER REPLACEMENT SHOULD BE CARRIED OUT BY SERVICE PERSONNEL ONLY, AFTER ENSURING THAT THE UNIT IS DISCONNECTED FROM THE MAINS SUPPLY.

The starters provide an extra spark to initially light the UV tubes. Starters wear out and should be replaced at the same intervals as the UV tubes.

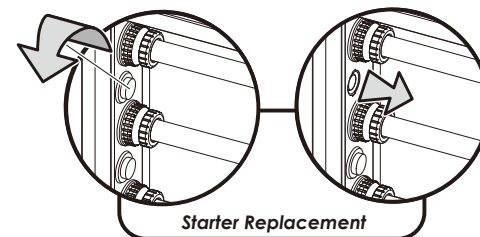

Starter Replacement

To replace the starters...

1. Release the starterholder cap by unscrewing it anti-clockwise.
2. Rotate the starter anti-clockwise.
3. Pull the starter free from the unit.

### SPECIFICATION / REPLACEMENT PARTS

Unit	Halo 45 Aqua
Voltage	230V ~ 50Hz
Dimensions(mm)	588 x 404 x 118
Coverage	120 Sq. Metres
Weight	7.0 Kg
Light Output	45W
Tubes	3 x TPX15-18S
Starter	3 x I154
Glueboards (x6)	GB013 (Yellow)