



MeacoFan

Seftē[®] Pro 10”

Pedestal Air Circulator

Sēf·tee: “Quiet, gentle and undisturbed”; in Old English

Instruction Manual

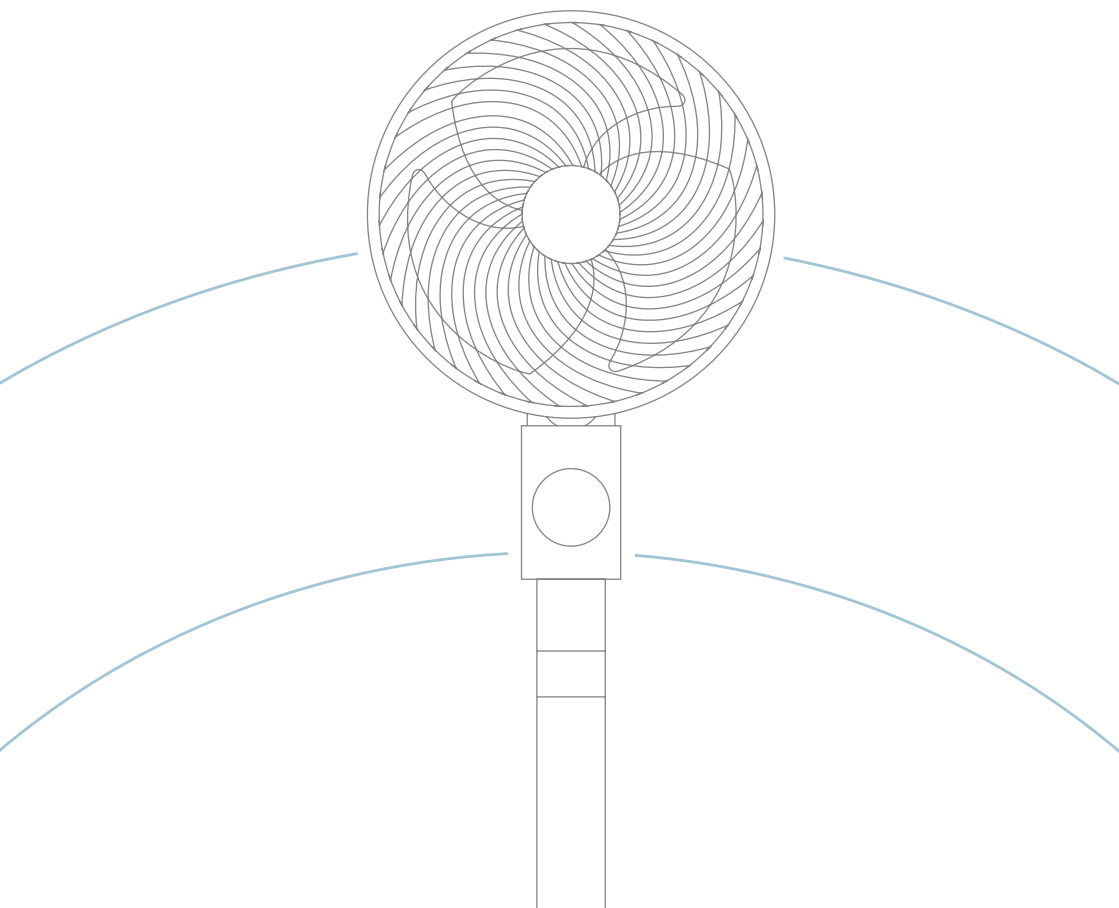

Thank you for choosing Meaco

Thank you for choosing Meaco, we really appreciate it. We built the Sefté® range of air circulators after years of research and customer feedback, engineering the perfect cooling product for you and your family. This product not only provides you with enhanced cooling, but is functional in its design and fits into your home.

This manual contains important information on the use and care of your air circulator. Please take some time to read this manual to take full advantage of your air circulators' many benefits and features.

Contents

Safety information	1
Register your Meaco warranty	3
Meaco app	4
What's included	5
Product identification	6
Assembly	7
Operation	8
Battery mode	11
Maintenance	13
Storing	15
Troubleshooting	15
Meaco customer care	15
Specifications	16
Warranty terms & conditions	17

Safety information

Important safety instructions



This air circulator must not be used in rooms under the following conditions: potentially explosive atmosphere, aggressive atmospheres, featuring a high concentration of solvents or an extremely high ratio of dust.

Magnets: The remote control contains magnets. Please note the following: Pacemakers and defibrillators may be affected by magnets. If this affects you, please do not put the remote control in a pocket and warn anyone who is likely to use the air circulator or the remote that it has a magnet. Credit cards and data cards can also be affected by magnets and should not be placed near to the air circulator remote.

Keep children away: Do not allow children to play with or around this unit, as it could result in injury. Be sure the unit is inaccessible to children when not attended. This appliance is not intended for use by persons (including children) with reduced physical, sensory or mental capabilities, or lack of experience and knowledge, unless they have been given supervision or instruction concerning use of the appliance by a person responsible for their safety.

Protect mains adaptor from damage: Never operate a unit with a damaged mains adaptor, as this may lead to electrical or fire hazards. If the mains adaptor is damaged, it must be replaced by a mains adaptor of the same type and amperage rating.

Extension cords: Extension cords must be grounded and able to deliver the appropriate voltages to the unit.

Handle with care: Do not drop, throw or crash the air circulator. Rough treatment can damage the components or wiring and create a hazardous condition.

Run on a stable surface: Always operate the air circulator on a stable, level surface, for example the floor or a strong counter, so that the air circulator cannot fall and cause injury.

Keep electrical components dry: Never allow water inside the air circulator's electrical components. If these areas become wet for any reason, thoroughly dry them before using the air circulator. If in doubt, do not use the air circulator and consult a qualified electrician or a Meaco approved engineer.

The operator must make the operating instruction available for the user and make sure that the user understands the manual.

Instructions about the WEEE



Correct disposal of this product (Waste Electrical & Electronic Equipment)

This marking indicates that this product or accessories should not be disposed of with other household waste at the end of their working life. To prevent possible harm to the environment or human health from uncontrolled waste disposal, please separate these items from other types of waste and recycle them responsibly. Users should contact either the retailer where they purchased this product, or their local government, for details of where and how they can take these items for environmentally safe recycling.

Declaration of conformity

Hereby, Meaco declares that this radio equipment is in compliance with Directive 2014/53/EU and with the relevant statutory requirements. The full text of the EU declaration of conformity and the UK declaration of conformity is available at the following internet address:
<https://www.meaco.com/pages/compliance-data>.

PSTI

Hereby, Meaco declares that this product meets the following requirements of PSTI Schedule 1 or 2. The full PSTI Statement of Compliance can be found here:
<https://www.meaco.com/pages/compliance-data>.

We will maintain security updates for at least 6 years from the launch day of related products. For more information visit: <https://www.meaco.com/pages/privacy-policy>.

Register your Meaco warranty

Your Meaco air circulator comes with a free three year warranty. Simply register your details online and you'll be covered for parts and labour for three years from the date of purchase, subject to the terms and condition of the warranty.

Where to find your air circulators serial number

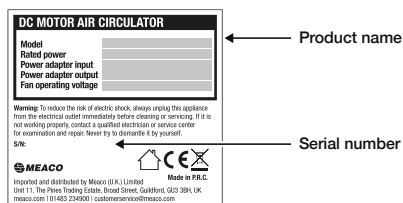

The serial number can be found on the rating label underneath the base of your air circulator.

Remember to keep a copy of your purchase receipt safe, you will need to show this to our Customer Service team should you need to make a warranty claim.

Ways to register your Meaco warranty



Register online

Visit our website to register your free three year warranty online:
<https://www.meaco.com/pages/register-your-warranty>

Register by phone

Call our Customer Service team to register your free three year warranty over the phone:
01483 234900 Opening times: Monday - Friday 9am - 5:30pm

Meaco App

Control your new air circulator with the Meaco app.



Scan the QR code to install the Meaco app or download the Meaco app from the App store or Google Play.

Open the app and follow the instructions to create a new account and pair your air circulator.

Connecting your air circulator to your Meaco app

1. Plug the air circulator into the mains via the mains adaptor and press the Standby ON button.
2. Hold the Mode button on the air circulator interface for 5 seconds.
3. The air circulator will beep and a Wi-Fi symbol will flash on the display.
4. In the Meaco app, press the + button in the top right hand corner and then 'Add device'.
5. The app will search for nearby devices and your air circulator will appear, click 'Add'.
6. Once the air circulator is successfully connected to Wi-Fi, the Wi-Fi symbol will stop flashing.

What's included

Carefully unpack the air circulator. Keep all packaging materials away from children.
We recommend flat packing and keeping hold of the box should you need it in the future.

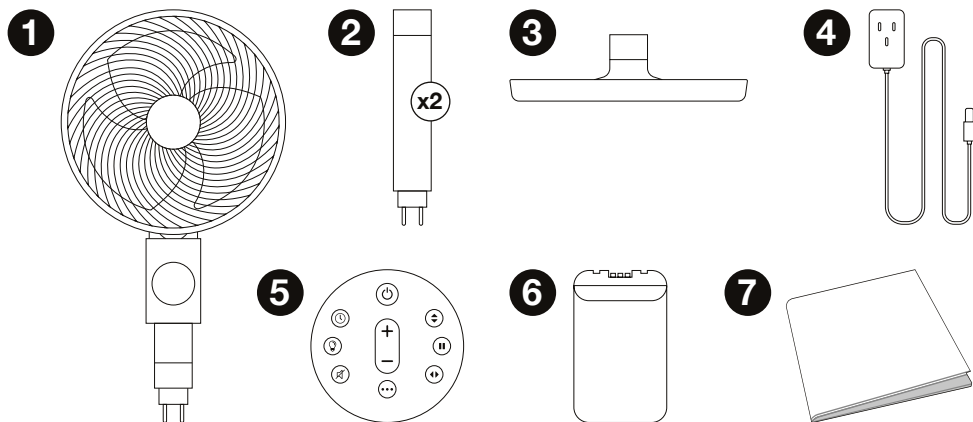

1. Meaco Sefta® Pro 10" Pedestal Air Circulator
2. Pedestal columns
3. Base
4. Mains adaptor
5. Remote control
6. Battery pack
7. Instruction manual

Product identification

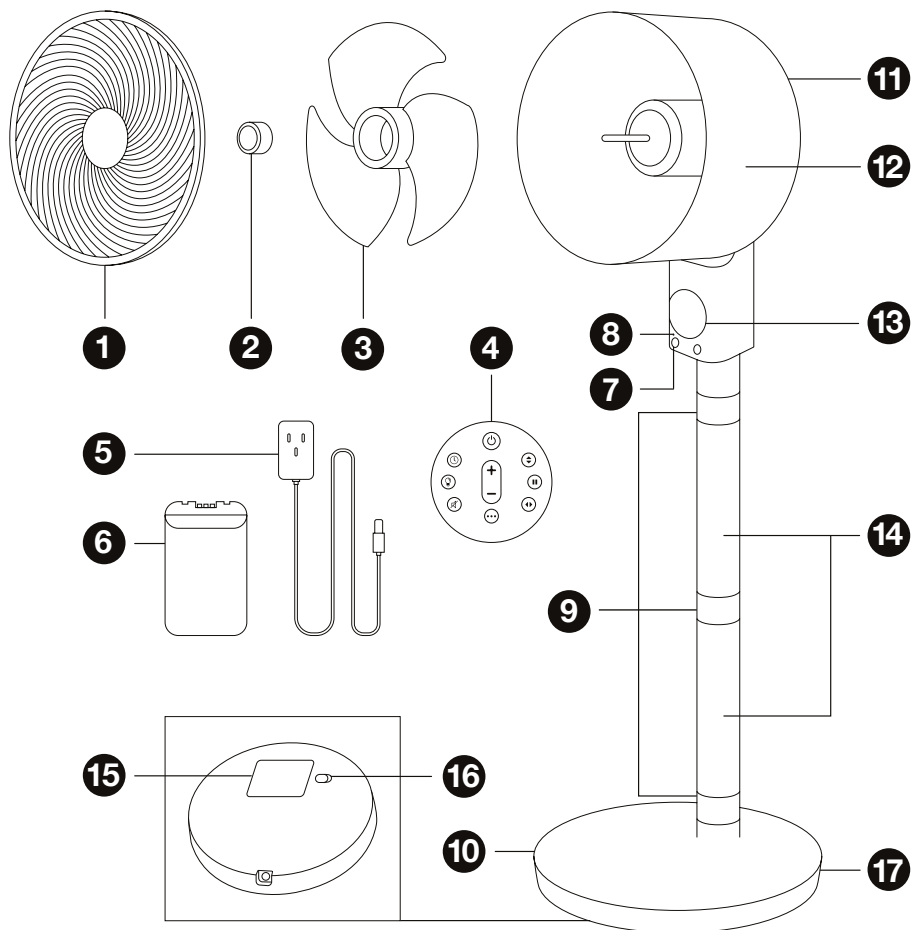

- | | |
|-------------------------|--|
| 1. Front grille | 10. Base |
| 2. Locking cap | 11. Handle |
| 3. Blades | 12. Back grille |
| 4. Remote control | 13. Display |
| 5. Mains adaptor | 14. Pedestal columns x2 |
| 6. Battery pack | 15. Battery compartment cover |
| 7. Interface | 16. Battery compartment cover release button |
| 8. Battery status light | 17. Mains adaptor input |
| 9. Security collar | |

Assembly

Warning: Do not plug the air circulator in before assembling.

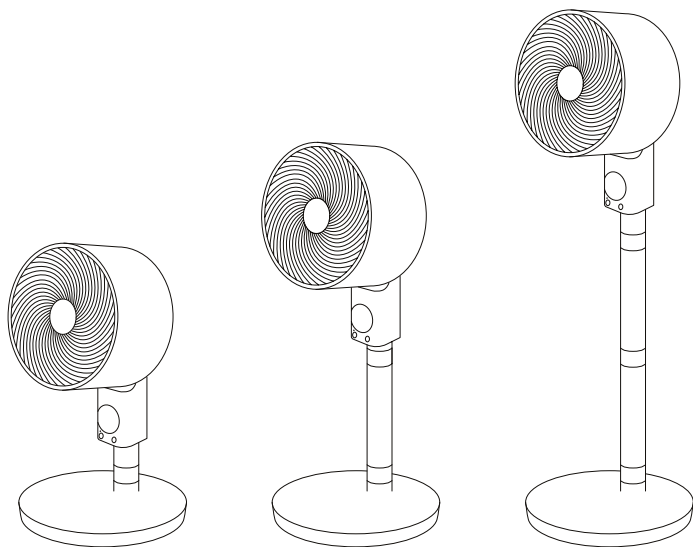

Assemble the air circulator according to your preference. The column/s can be attached for increased height or the air circulator head can be attached directly to the base creating a table air circulator.

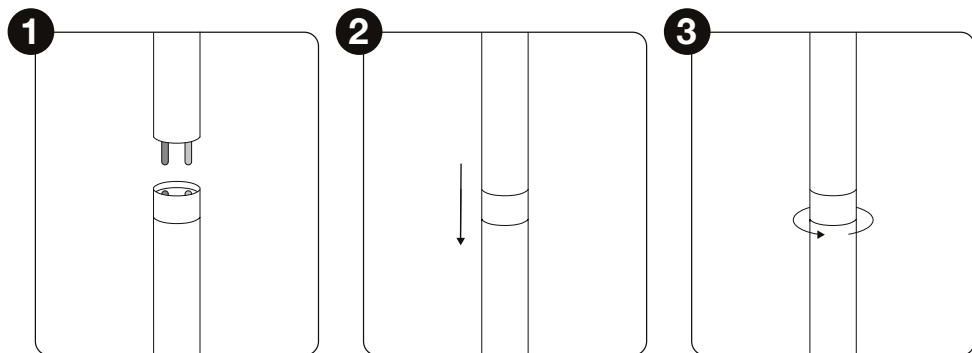

To attach the column/s and air circulator head align the gold metal guide pin with the gold hole and insert to bring the poles together. Turn the security collar counter clockwise until it is securely tightened.

Operation

When the air circulator is plugged into the mains, the air circulator will beep once and the battery status light above the power button will turn on, the air circulator is in Standby mode.

Interface

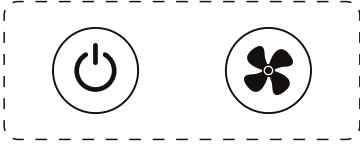

Power button: Press the power button once to turn the air circulator on and press the power button again to turn the air circulator off. To turn the air circulator power off, unplug it from the mains.



Fan speed: Short press the button to increase the fan speed between 1 and 12. When 12 is reached, pressing this button again will take you back to 1. Hold down the button to move through the three modes: Normal, Night and ECO. See page 8 for descriptions of each mode.

After a setting is adjusted, the interface will revert back to displaying the room temperature and the set mode (unless in Night mode where the interface will turn off).

The following functions are only available via the remote control.



Vertical oscillation: There are 3 angles of vertical oscillation. Press the vertical oscillation button to move through narrow (1), medium (2) and wide (3) oscillation. Once selected, the display will revert back to displaying the room temperature. To turn off vertical oscillation, press the vertical oscillation button until 0 appears on the display. The moment 0 is reached, the fan will remain in that angled position.



Pause: Press the button to pause the oscillation at any point, both the vertical and horizontal oscillation will pause.



Horizontal oscillation: There are 3 angles of horizontal oscillation. Press the horizontal oscillation button to move through narrow (1), medium (2) and wide (3) oscillation. Once selected, the display will revert back to displaying the room temperature. To turn off horizontal oscillation, press the horizontal oscillation button until 0 appears on the display.

Oscillation type	Display	Degree of vertical oscillation	Degree of horizontal oscillation
Narrow	1	20°	30°
Medium	2	30°	75°
Wide	3	65°	120°



Timer: Use the timer button to set an ON or OFF timer. To remove either the ON or OFF timer, press the timer button until you reach '00 hrs'.

Timer on When the air circulator is in standby mode, use the timer button to move between 1 and 12 hours in which the air circulator will turn on. When you reach the desired number of hours on the display, pause, and then the air circulator will beep twice to lock in your selection. The interface will display the number of hours in which the air circulator will turn on e.g. '03 hr'.

Timer off When the air circulator is on, use the timer button to move between 1 and 12 hours in which the air circulator will turn off. When you reach the desired number of hours on the display, pause, and then the air circulator will beep twice (unless in Night Mode) to lock in your selection.



Light: Press the light button to turn off the display above the power button. Press again to turn back on.



Mute: Press the mute button to silence the buttons on the air circulator. The air circulator will beep when the mute button is pressed and then will no longer beep when any other buttons are pressed. Press the mute button again to unmute.

Hold the mute button down for more than 5 seconds to change the temperature on the display between °C and °F.

Battery mode

The air circulator can be used in battery only mode, meaning the mains adaptor is not required.

- Battery type required: 9200 mAh Li-ion rechargeable battery.

Battery installation

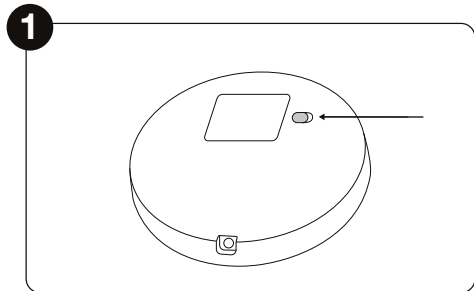

Press the button on the right hand side of the air circulator to release the lid.

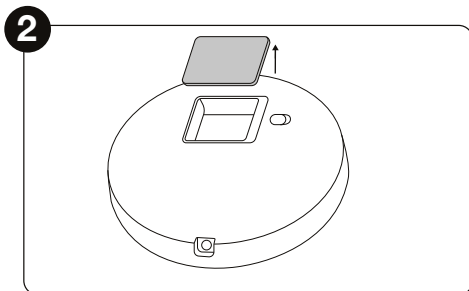

Remove the battery pack compartment cover.

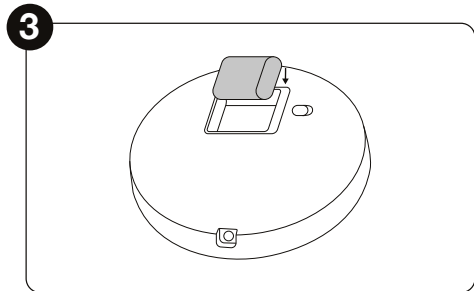

Insert the battery pack into the battery compartment.

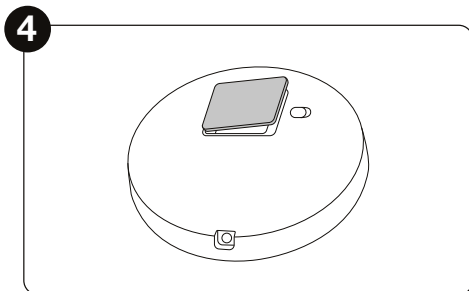

Put the battery pack compartment cover back in place.

Charging the battery

When charging the battery, actual energy consumption can be greater than the values in the Specifications section.

Charging the battery to 100% will take approximately 3.5 hours.

To charge the battery, simply make sure the battery is in place in the air circulator (as per the instructions above) and plug the air circulator into the mains using the mains adaptor.

Battery status

Above the power button on the air circulator interface is an LED light showing the battery status.

Please note the LED display will not be visible when the device is on night mode.

Solid white	Fully charged
Flashing white	Charging - less than 100% charge
Solid red	Less than 20% charge
Flashing red	Less than 10% charge

Battery life

See the table below for the approximate battery life while using different fan speeds.

Battery life		
Fan speed	No oscillation	Full oscillation
1	40 hours	11 hours
2	35 hours	10 hours
3	33.5 hours	9.5 hours
4	27.5 hours	9.5 hours
5	25.5 hours	9 hours
6	21.5 hours	8.5 hours
7	19 hours	8.5 hours
8	16.5 hours	7.5 hours
9	14 hours	7 hours
10	12 hours	6.5 hours
11	10 hours	6 hours
12	10 hours	5.5 hours

Battery disclaimer

Lithium-ion batteries are designed to go through a continuous cycle of being recharged – if this happens consistently they will continue to perform at their best. If the battery is not recharged for a period of more than 3 months the battery performance will reduce by 50%. Due to the nature of our products, it is more than likely the battery will not be recharged over the winter period and therefore suffer a performance decrease. We therefore recommend you recharge your fan every 3 months for 2 hours. If you forget to do this and find the performance of the battery has been reduced, you can purchase a new lithium-ion battery.

The batteries used in our fans are the most up to date form of lithium battery, the performance decrease indicated above is just the nature of this type of battery. We use lithium-ion batteries as they are the most efficient battery. They are rechargeable and charge in the shortest amount of time keeping energy costs to a minimum. We therefore believe the positives of using lithium-ion batteries outweigh the negatives.

Maintenance

Cleaning your air circulator

To ensure your air circulator is always performing at its best, it's important to regularly clean it.

- Always unplug your air circulator from the mains before cleaning.
- Do not allow the air circulator to get wet.

Use a soft dry cloth to clean the external and internal parts of the air circulator. To access the fan blades, following the steps below:

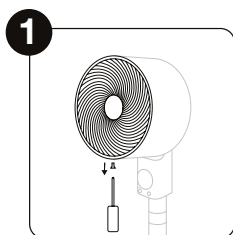

Using a screwdriver, unscrew the screw at the bottom of the air circulator head.

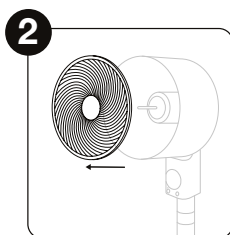

Hold the grille on the left and right side of the air circulator and rotate anti-clockwise to remove the grille from the head.

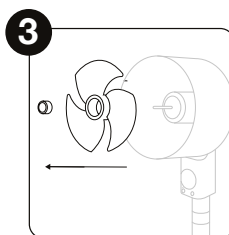

Unscrew the locking cap in the centre of the air circulator in a clockwise motion to remove the fan blades.

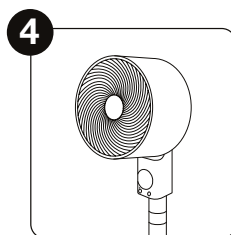

Reverse the steps above to put the air circulator back together. Make sure the locking cap is tightened securely.

Replacing the remote control battery

If the remote control fails to work within 4 metres of the air circulator, replace the battery.
Battery type: CR2025 or CR2032. To replace the battery follow the steps below:

Keep batteries away from children!

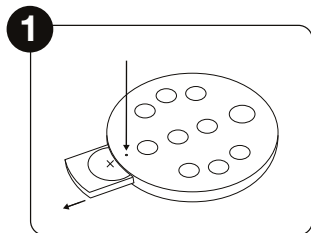

1 Push the safety release (below the Mode button) with the end of a paper clip to release the battery compartment.

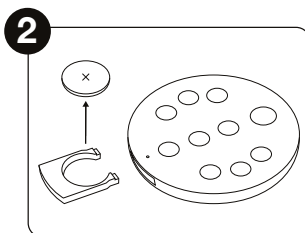

2 Replace the battery making sure the polarity is correct.

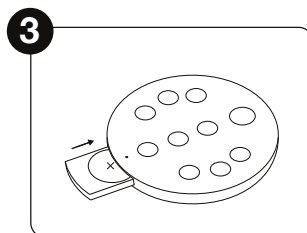

3 Push the battery and battery compartment back into the remote control.

Storing

Store the air circulator in a clean, dry place in its original box. Alternatively, a custom storage bag can be purchased from meaco.com.

When the air circulator is not going to be used for more than 3 months, we recommend charging the battery for 2 hours and then removing it from the air circulator to prevent a reduction in the battery's performance. 2 hours will not charge the battery to 100%, it will charge the battery to 50% which is the optimum charge to prevent a reduction in performance. Repeat the charging process once every 3 months. Store the battery in a cool, dry place away from children.

Tip! The air circulator can also be used in winter to help distribute warm air more effectively within a room. It can also be used in conjunction with a dehumidifier to circulate dry air and dry your laundry faster.

Troubleshooting

If you come across a problem with your air circulator, check the table below and try the suggestions. If the problem persists, contact Meaco.

Error	Action
Fan blades not moving	Check the adaptor is connected correctly
Increased noise level	Clean the fan blades Make sure the locking cap is tightened securely
E1	Contact Meaco
E2	Contact Meaco

Meaco customer care

If you have a question about your Meaco air circulator, contact our Customer Service team who will be happy to help. Make sure you have your serial number and details of where and when you purchased your air circulator.

Meaco contact details

Website: meaco.com

Email: customerservice@meaco.com

Phone: 01483 234900

Address: Meaco, Unit 11, The Pines, Broad Street, Guildford, Surrey, GU3 3BH, United Kingdom

Specifications

Some specifications will differ depending on how your air circulator is powered: by mains adapter or by battery. The specifications below are for when the air circulator is powered by mains adapter. For the full list of specifications visit meaco.com. Information to identify the model(s) to which the information relates to MeacoFan Seft® Pro 10" Pedestal air circulator.

Description	Symbol	Value	Unit
Maximum fan flow rate	F	[19.18]	m ³ /min
Fan power input	P	[36]	W
Service value	SV	[0.8]	(m ³ /min)/W
Standby power consumption	PSB4	[0.5]	W
Fan sound power level	LWA	[25]	dB(A)
Maximum air velocity	c	[7.07]	m/s
Noise level	LWA	[25]	dB(A)
Voltage	-	[220-240]	V
Power consumption	-	[6 - 26]	W
Dimensions (HWD)	-	[591~1098x340x340]	mm
Nett weight	-	[5.8]	kg
Measurement standard for service value	Veordnung (EU) Nr. 206/2012 + (EU) Nr. 2016/2282 EN IEC 60879:2019 EN 50564:2011 EN 60704-1:2010 + A11:2012 EN IEC 60704-2-7:2020		

Contact details for obtaining more information

Website: <https://meaco.com/pages/contact-us>
 E-Mail: customerservice@meaco.com
 Telephone: 01483 234900
 Address: Unit 11, The Pines Trading Estate, Broad Street,
 Guildford, GU3 3BH, United Kingdom

Warranty terms and conditions

There is a three-year manufacturer's warranty on your air circulator from the date of delivery. Within the three-year warranty, all manufacturing defects will be repaired free of charge.

The following applies:

1. Any repair or replacement of your air circulator or its components during the warranty period will not result in an extension of the warranty period.
2. If your air circulator has been opened or tampered with or not genuine components have been fitted by yourself or anyone other than a Meaco engineer, your warranty is invalid. This does not include removing the air circulator grille to clean the fan blades.
3. Components subject to normal wear and tear, the Li-ion battery, remote control and mains adaptor are not covered by the warranty.
4. The warranty is only valid on presentation of the original, unaltered and date-stamped purchase receipt. If you are unable to produce proof of purchase, the warranty on your air circulator is invalid.
5. The warranty does not cover damage caused by actions that deviate from those as described in the instruction manual or by neglect.
6. The warranty does not cover faults caused by dirt or by third-party products.
7. Using a third-party switching device that turns the air circulator on or off via the mains will invalidate the warranty for example, a Smart Plug.
8. The warranty does not cover accidental damage.
9. All claims for compensation, including consequential damage, will not be entertained.

For the full list of the warranty terms and conditions please visit: www.meaco.com/warranty-terms.

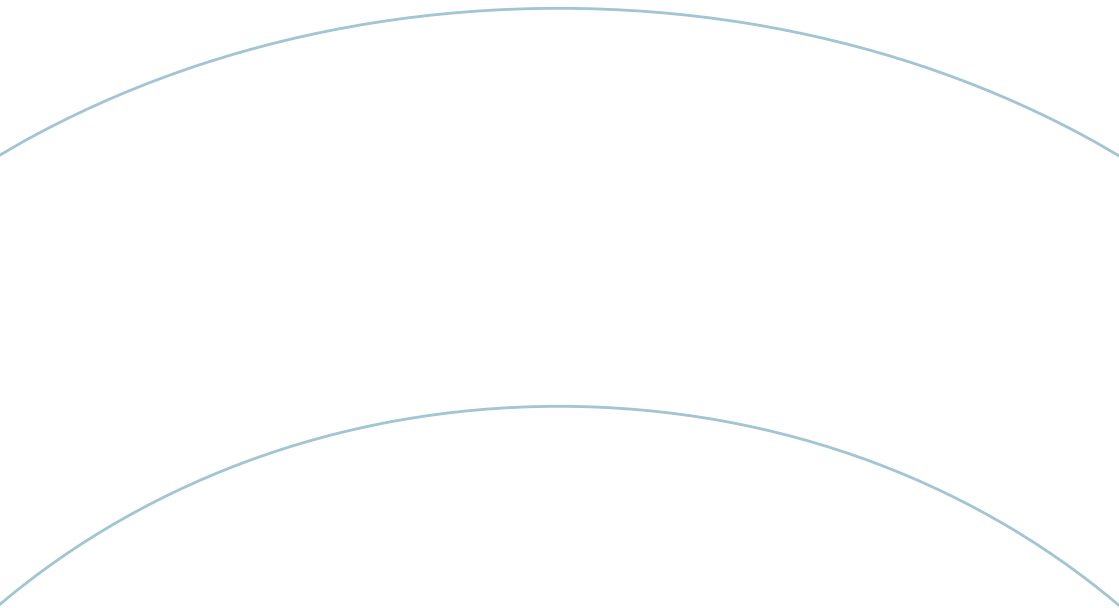

The mark of
responsible forestry